

POP-IN

be anything.

EN



Inspirations

Inspirations

- Office interior
- Trade show
- Retail

- 6
- 6
- 6
- 7

Elements

Glass frame

Square 62 Profiles & new Corner Piece

Glass Sections

- 10
- 14
- 16

Features

Modularity

- Track light system
- LEDskin®
- Light box

- 22
- 22
- 22
- 22

Standards

3 × 3 Module

6 × 3 Module

The 8 beMatrix principles

bePartners at your service

- 26
- 27
- 28
- 30

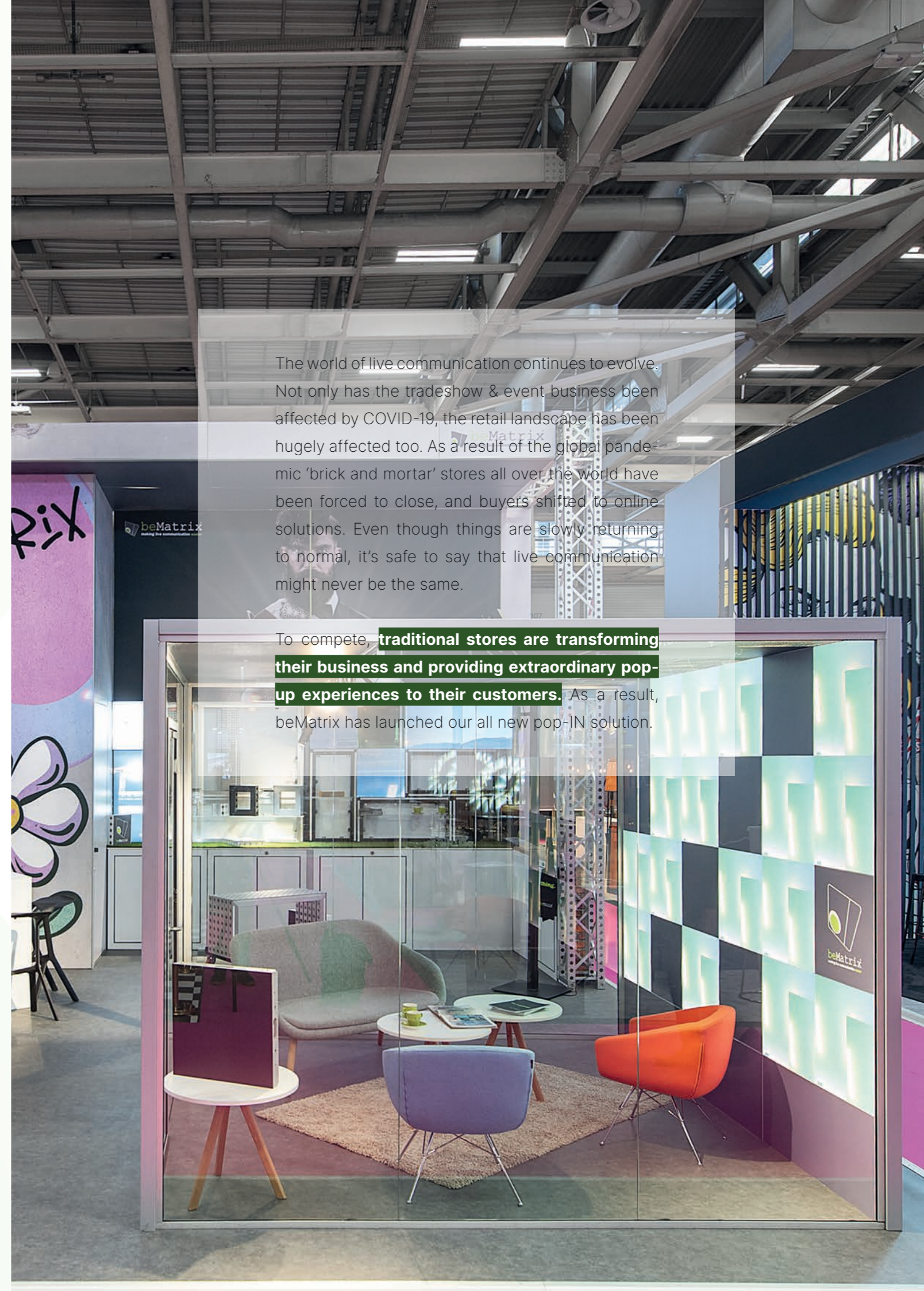

The world of live communication continues to evolve. Not only has the tradeshow & event business been affected by COVID-19, the retail landscape has been hugely affected too. As a result of the global pandemic 'brick and mortar' stores all over the world have been forced to close, and buyers shifted to online solutions. Even though things are slowly returning to normal, it's safe to say that live communication might never be the same.

To compete, **traditional stores are transforming their business and providing extraordinary pop-up experiences to their customers.** As a result, beMatrix has launched our all new pop-IN solution.



01

Inspirations

Inspirations

Pop-IN is a flexible concept for indoor pop-up activities. With the addition of just 2 elements to our existing range, you can open up a new world of opportunities using your existing inventory.

Office interior

Your office interior needs to adapt to your company's growth and employee's needs. Pop-IN offers you a solution without the need for large-scale refurbishing.



Trade show

Pop-IN's elements are fully compatible with the existing beMatrix frame system letting you integrate pop-IN into your next event or exhibit design.



Retail

With pop-IN you can create a unique pop-up shop concept, that entertains consumers with short-term 'wow' experiences.





02

Elements

Glass frame

Glass as an infill is also an option and mounting becomes quick and easy with the **glass frame**. This innovative solution allows you to integrate **a glass section** in your design: the perfect eye-catcher, without too much hassle.

This **welded frame** offers all the advantages of standard straight b62® frames, whilst you can still mount these frames next to and on top of each other, using your trusted beMatrix connectors.

True to our beMatrix DNA, this glass frame is fully compatible with your existing stock. The glass is mounted securely with the accompanying **glass mounting set**.



Next to the welded frame, you also have the option to build with **loose profiles**. Its main advantage: there are no visible profile edges between the glass sections. Important here though is to provide sufficient solidity around the glass, using, for example, a corner profile on top of the glass profiles.



Our glass frame is also suitable for use with plexi and other types of infills, with a thickness between minimum 3 and maximum 16 mm. Please note thickness requirements may vary from country to country, depending on local regulations.





©No Limits

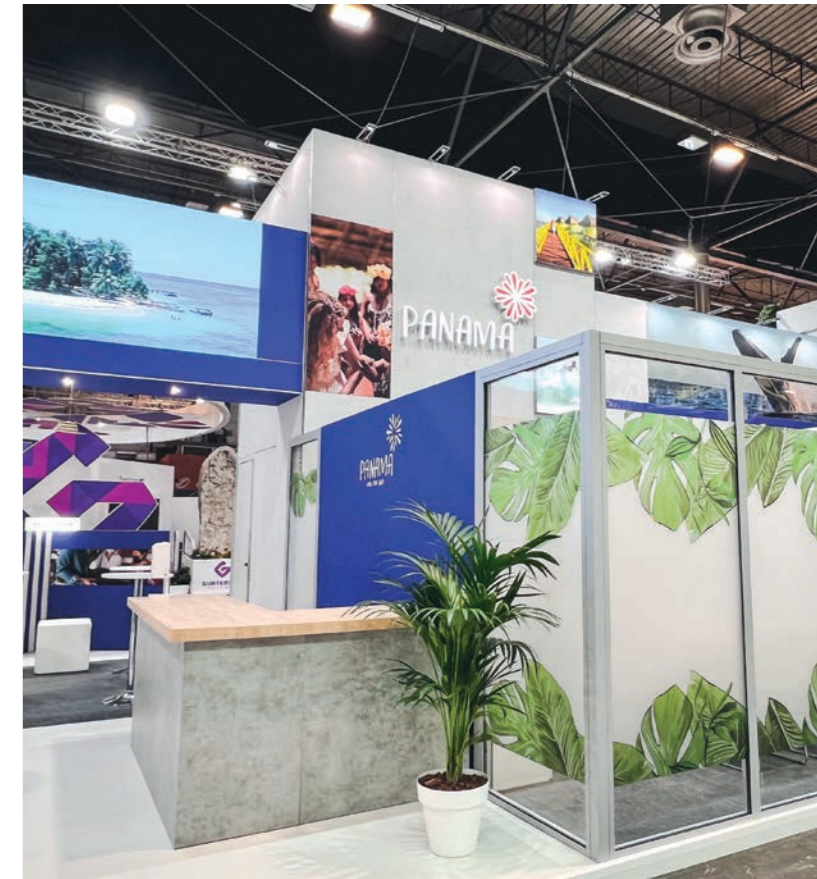

Square 62 Profiles & new Corner Piece

The corner piece is designed with the beMatrix DNA. It's easy to use during build-up and ensures flexibility of design. The corner piece helps to **ensure a robust pop-IN design** with a maximum height of 2.5 m. By combining this corner piece with existing beMatrix Square 62 profiles, you can get a high-end finish to your pop-IN design.

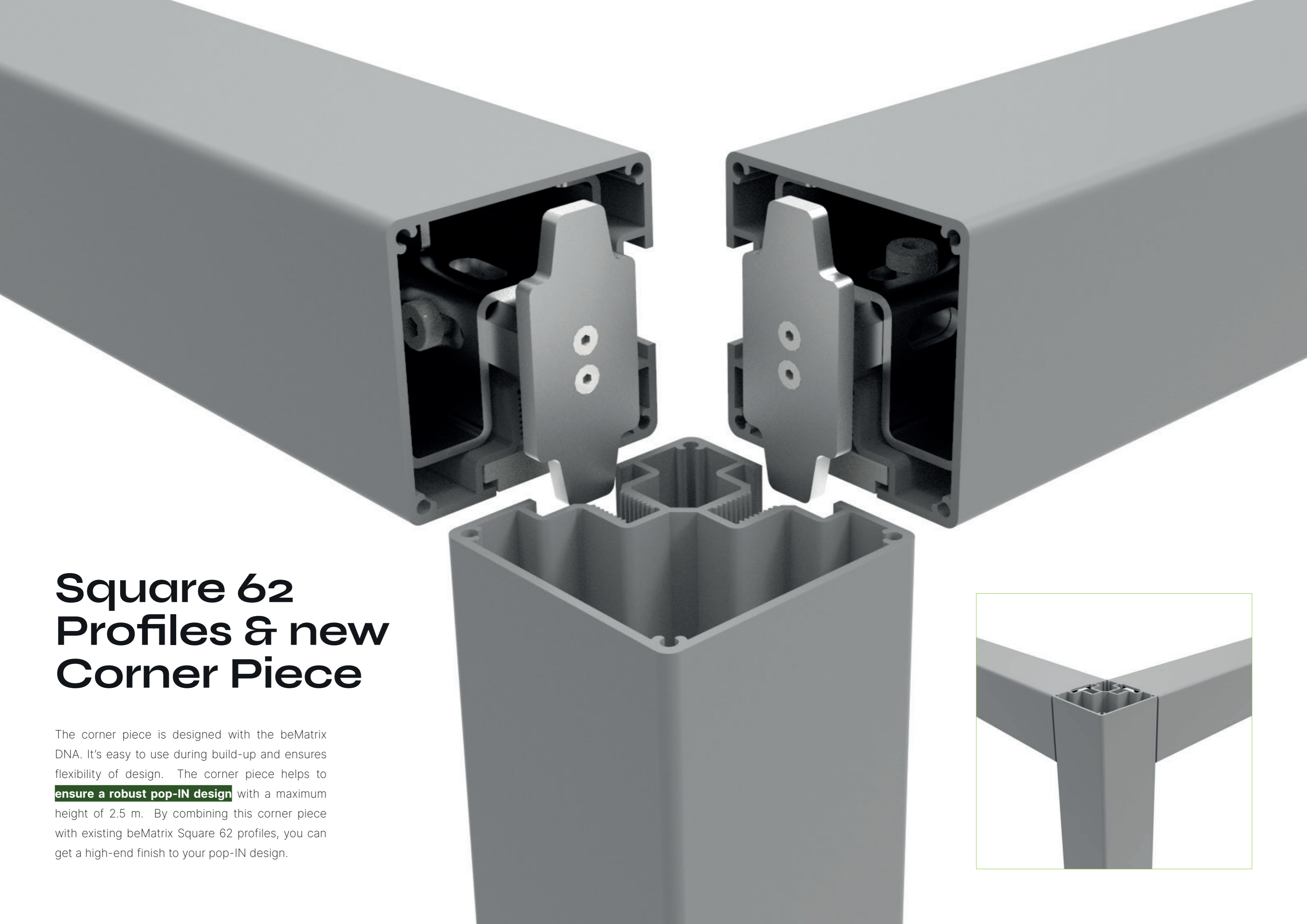

Glass Sections

Enter the pop-IN through the door located in one of the glass sections. The **adjustable door with door pump, and digital lock**, has a slim design so it integrates easily into each pop-IN design.

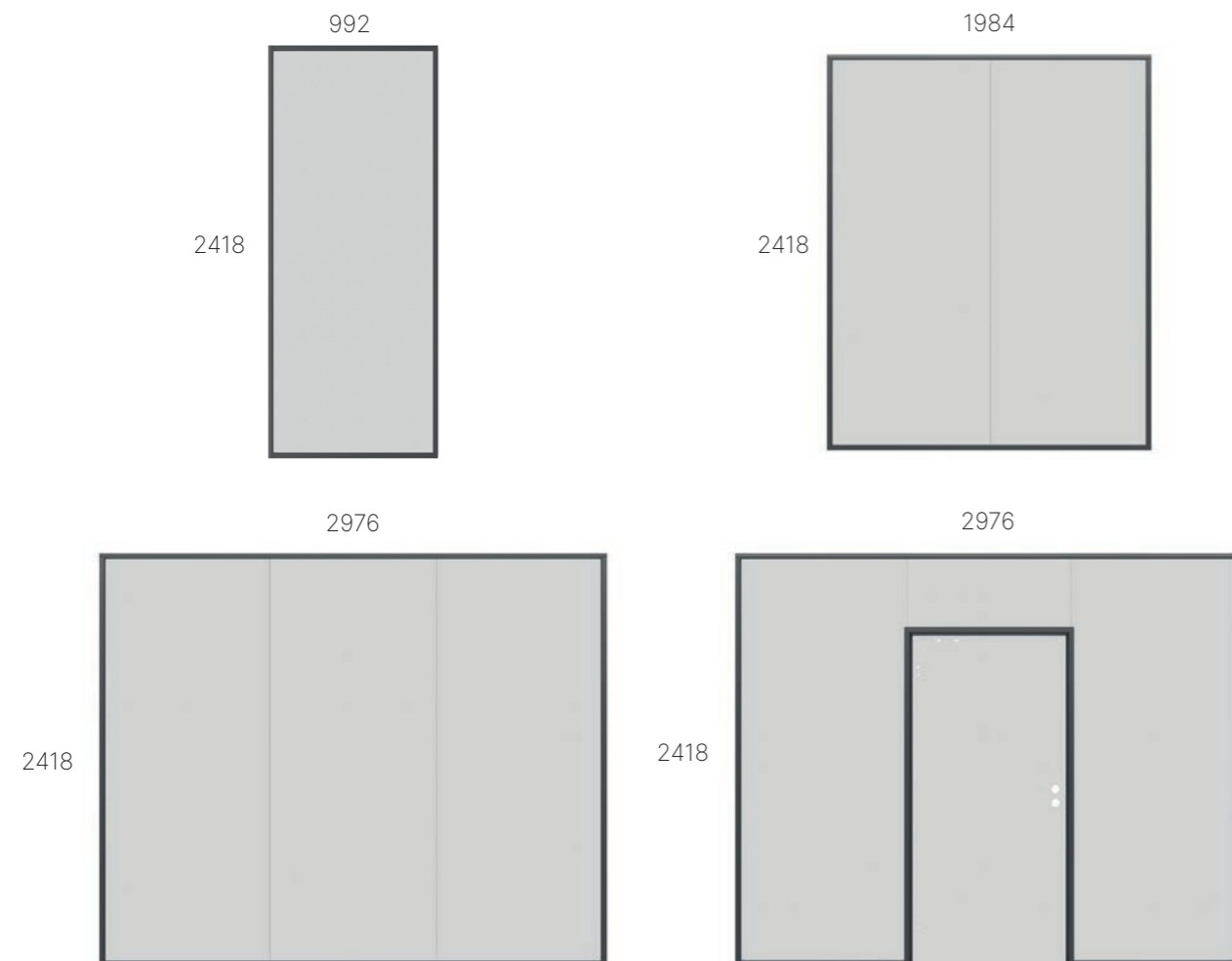



beMatrix
Manufacturer of the
original frame system
with big holes.

beMatrix
be linear
be curved
be anything.



03

Features

Modularity

Pop-IN is part of the beMatrix family and can be connected to your existing b62 frame inventory. Finish your pop-IN module the way you want, or start building from your pop-IN to make your brand stand out.

Track light system

With the beMatrix Track Light System cabling is no longer an issue. The track profile allows you to add **adjustable, and seamless lighting** to your pop-IN design. The beMatrix 62 x 62 profile matches the existing EUTRAC profile. Thanks to the beMatrix modular DNA, it's possibilities are endless. Mount a number of standard Delta Light models available in our range to your pop-IN.



LEDskin®

Pop-IN perfectly integrates LEDskin®, as shown in this inspiring design. LEDskin® frames are available in 3 pixel pitches: 1.9, 2.5 and 3.1 mm. This guarantees **optimal resolution, brightness and responsivity**. Thanks to the dimensions of the LED panels they fit perfectly within the beMatrix concept. Both frame and LEDskin® have a thickness of 62 mm.

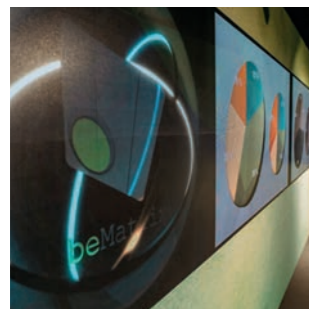

Light box

Light up your pop-IN with a lightbox. beMatrix lightboxes **can easily be integrated** in our pop-IN system without any tools. You can choose between single-sided and double-sided lightboxes. The result is a minimal and flawless look.

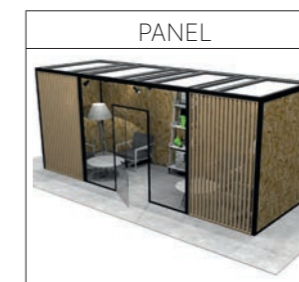
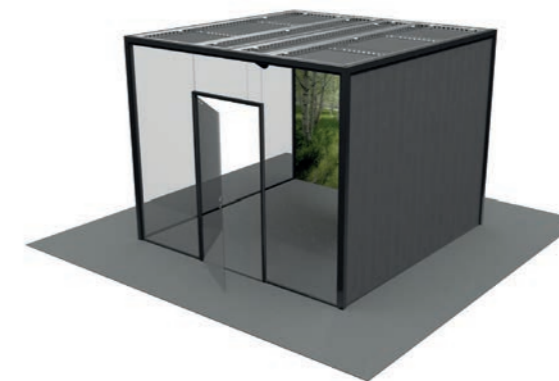
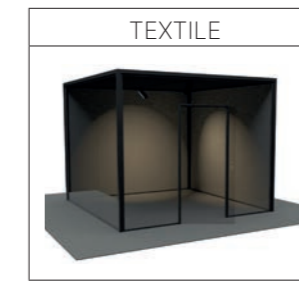

4 sides can be finished in different ways



o4 standards

3 x 3 Module

ART. NR: 440 000 B/G

DIMENSIONS: 3100 x 3100 x 2480 mm

ADDITIONS:

- Ceiling, Tracklight & 2 lights included
- Door with door pump & digital lock included



6 x 3 Module

ART. NR: 440 001 B/G

DIMENSIONS: 6138 x 3100 x 2480 mm

ADDITIONS:

- Ceiling, Tracklight & 6 lights included
- Door with door pump & digital lock included



The 8 beMatrix principles



Quality guaranteed

All beMatrix frames are manufactured in-house, so we are in control of every step in the production process. Continuous optimisation and innovation initiatives ensure the system always complies with the market's demands.



Top finishing

The beMatrix stand building system comes with a large range of tools and accessories to finish your stand exactly the way you envisage it. With the infills, you can even hide the entire frame system so it becomes invisible to the eye. Thanks to our 'seamless' concept, not one seam will be noticeable.

Freedom to design

A beMatrix stand combines the benefits of a modular system with the possibilities of made-to-measure solutions. Almost any shape, contour and construction is conceivable and can easily be created. One single frame allows you to create all different kinds of stand concepts.



Lightweight

The aluminium frame system is lightweight, hence very ergonomic and eco-friendly: no need for the stand builder to carry around heavy structures, while the transport weight and CO2 emissions remain low.



Fast

Assembly and disassembly of the beMatrix system takes hardly any time. Its weight, simplicity and tool free assembly save loads of time, leaving you space to focus on the finishing details of your stand. Isn't that what makes you stand out most at a fair?

Long life cycle

The system is extremely sturdy, making it endlessly reusable. Wear and tear won't shorten its life cycle, since the frame is not visible to the eye once the entire stand is set up.

Ecologically sound

Because of its low weight, long life cycle and modular character, the beMatrix frame system is the eco-friendliest system today. Moreover, it is made out of untreated aluminium, so 100% recyclable and reusable without any quality losses.

International network

The bePartner network brings together real ambassadors of the beMatrix frame system, each with their own expertise: stand building, textile printing, LEDskin®, Double Deck... A creative cross-pollination offering you as our client nothing but benefits.



bePartners at your service

bePartner LEDskin®

Our LEDskin® bePartners all stock a minimum amount of LEDskin® and have years of expertise in the audiovisual industry. They are more than happy to help you perfectly integrate LEDskin® in your beMatrix stand.

bePartner printed textiles

Printing customised textiles takes real precision. Our bePartners for printed textiles have proven they totally master this specialised skill and guarantee perfect service, time and again.

bePartner build

Our bePartners build have a large stock of frames and accessories, integrate our latest innovations, are able to think outside the box and consider optimal service to be of paramount importance.

bePartner LEDskin® content

Do you already have LEDskin® available, but are you still looking for a partner to help you with content? Our content partners will advise and assist you, from content creation up to and including optimal display quality on your LEDskin® system.

bePartner printed panels

Printing infill panels for our beMatrix frames might seem simple, but this specialised job really has to be executed in a very precise way. Our bePartners for printed panels have already proven they totally master this specialised skill and guarantee excellent service, time and again.



be strong  **be stylish**
be anything.

Come say hi

HQ Belgium
Wijnendalestraat 174
8800 Roeselare

get in touch

+32 (0)51 20 07 50
info@beMatrix.com

or boost your inspiration

www.beMatrix.com
socials @beMatrix
